



Expansion Modules Installation Manual



OP465
Analog Input
7-channel

OP461
Analog Output
4-channel

OP750
Safe Module
Plus

OP653
Digital Input
8-channel,
isolated

OP654
Digital Relay Output
6-channel,
isolated

Welcome,

Thank you for choosing Mission Communications for your monitoring and alarm needs. Mission is committed to providing the highest quality of SCADA solutions. All products go through a strict testing regimen before leaving the facility to ensure a seamless installation experience.

Mission provides customers with 24-hour access to Technical Support. Additionally, Mission hosts a wide range of information that can be remotely accessed through the web portal, such as training videos, support documents, and more. The Mission goal is to provide customers with the latest technology and designs while ensuring great value.

Weekly training webinars are available most Wednesdays at 2 P.M. Eastern. Quarterly newsletters and training videos on are available on the website. Visit 123mc.com to sign up for the webinar and to find training videos and the newsletter archive. Mission Technical Support is available at (877) 993-1911 option 2 for further assistance.

Thank you,
The Mission Team

Mission offers a variety of related documents. Scan the QR code with a smartphone or visit 123mc.com/literature to view.



Warning: This symbol indicates there is caution or warning to avoid damage to your property or product.



Warning: Follow requirements for field wiring installation and grounding as described in NEC and your local/state electrical codes.



Note: This symbol indicates that there is something that requires your special attention.



This device complies with part 15 of the FCC Rules. Operation is subject to the following two conditions: (1) This device may not cause harmful interference, and (2) this device must accept any interference received, including interference that may cause undesired operation.

Contents

Chapter 1: Overview	4
Chapter 2: Location	6
Chapter 3: Communications Cable	6
Chapter 4: One or Two Expansion Module Hookup	7
Chapter 5: Pre-Installation	8
Chapter 6: Safe Module Plus (PN OP750)	9
Chapter 6.1: SMP Pulse Inputs	14
Chapter 6.2: SMP DIN Rail Mount and Release	15
Chapter 7: Analog Input (PN OP465)	16
Chapter 8: Analog Output (PN OP461)	18
Chapter 9: Digital Input (PN OP653)	19
Chapter 10: Digital Relay Output (PN OP654)	20
Appendix A: Upgrades from Legacy RTUs, Wet Well Modules, and Pulse Counter Option Boards	21
Appendix B: Troubleshooting	22
Appendix C: Three or More Expansion Module Hookup	23
Appendix D: Long Cable Runs, Terminating Resistor	25
Appendix E: Pulse Input (PN OP464, discontinued)	26

Chapter 1: Overview

Expansion modules increase the monitoring possibilities of the MyDro remote terminal unit (RTU). Mission provides options for expanded input/output (I/O) based on ADVANTECH modules and those of our own design. The Safe Module Plus expansion module brings useful features to sewer lift station monitoring, fresh water pump lock-out applications, and rain sensing applications. Read more about this in the specification sheet. Additional modules are available for expansion of Analog Input, Analog Output, Digital Input, and Digital Relay Output.

The MyDro RTU will recognize the module once it is installed and will publish the readings to the LCD screen and the web portal. Configurable options will be presented on the LCD screen under the Config. menu. The web portal is used to create alarm notification rules for the new I/O including alarm delays, analog threshold, and flow (pulse) thresholds. The MyDro 850 RTU is recommended for use with Digital Input, Digital Relay Output, Analog Input, and Analog Output Expansion Modules. The MyDro 150 and 850 are both compatible with the Safe Module Plus.

The expansion modules provide signal conditioning, isolation, ranging, and A/D and D/A conversion. Digital communication to the MyDro is based on a unique device ID and cable (RS485 2-wire, plus power). The device ID has been set by Mission at the factory as indicated on the label.

Multiple expansion modules can be daisy-chained together (wired in parallel). At this time the MyDro supports one each of the various modules. In other words, up to 5 unique modules can be connected in parallel. See Table 1 for more details.

Setup forms for all modules are available online. Use the camera of a smartphone to email the form. Please complete and send the form to Technical Support as quickly as possible so reports will be labeled appropriately and the notification system will enunciate call-outs properly.

The MyDro RTU can source up to 3 watts over the included communication cable.

Table 1:
Expansion module part numbers, functions, and power requirements.
Max power* requirement of the Module does not include instrumentation.

MyDro Expansion Modules	On Main Board	Expansion Available I/O	Dev ID in Decimal	Max Power*	RTU	ADVANTECH PN
Safe Module Plus OP750	DI 4 on mainboard not used	1 intrinsically safe float input (presented as DI 4) and locally available as a relay output, 4 pulse channels	TBD	0.5 W	M150 or M850	N/A
Analog Input OP465	2	AI 3–AI 9	20	1.2 W	M850	ADAM-4017+-CE
Analog Output OP461	0	AO 1–AO 4	40	3 W	M850	4024-B1E
Digital Input OP653	8	DI 9–DI 24	10	1 W	M850	4051-BE
Digital Relay Output OP654	3	4-9	50	2.3 W	M850	ADAM–4069
*Pulse Input OP464-30	0	1–2	30	2 W	M150 or M850	4080-DE
*Pulse Input OP464-31	0	3–4	31	2 W	M150 or M850	4080-DE

* Pulse Input (OP464-30) is discontinued and cannot be ordered but can still be connected. See Appendix E for installation information.



Note: Labels are attached to indicate Mission I/O nomenclature. For example, Mission expanded digital I/O starts with digital input (DI) 9 to complement the way expanded digital inputs appear on the web portal ADVANTECH documentation describes that input as DI 0. Mission does not currently support all features and inputs of some expansion modules.

Chapter 2: Location

In most cases, the included 8-foot communications cable allows the expansion modules to be mounted on the back panel of the control cabinet and the other end connected to the nearby MyDro RTU.

The expansion modules can be mounted on a DIN rail or directly to a backplate in the control cabinet. Signal cables should be run in conduit if the module is mounted in the Mission NEMA 1 or NEMA 4 enclosures. No load carrying wires should be run in the same conduit as signal wires.

The RS485 communications standard (differential balanced line over twisted pair) supports distances up to 4,000 feet.

Chapter 3: Communications Cable

The RJ45 end of the included cable plugs into the RS485 port (left side) of the MyDro. One twisted pair is for communications while the other powers the expansion modules. Do not connect or remove the RJ45 end into the MyDro board until all wiring to the expansion module is complete. The four conductors terminate on the expansion modules as follows (see Table 2):

Table 2:
RS485 Connection

Label	Wire Color
GND	Bk—Black
+Vs	R—Red
DATA -	Gr—Green
DATA +	W—White

Chapter 4: One or Two Expansion Module Hookup

Avoid routing the communications cable parallel to other load carrying conductors. Figures 1A and 1B demonstrate a single module network powered by the communications cable. For an example of a multiple module hookup, see Appendix C. See Appendix C for powering modules from a power source other than MyDro aux terminal as well as applications requiring more than two expansion modules.

Figure 1A:
Safe Module Plus

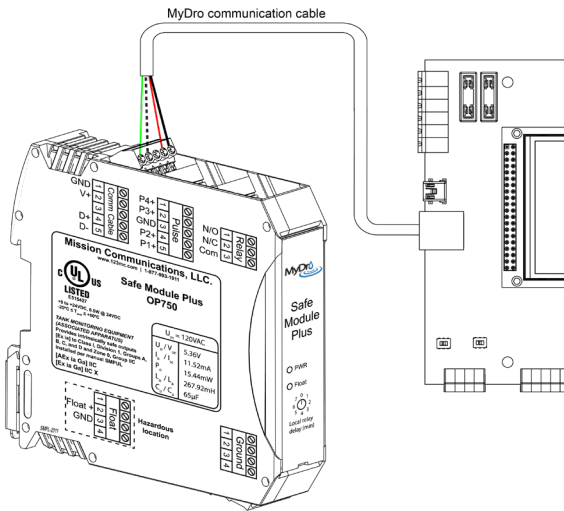
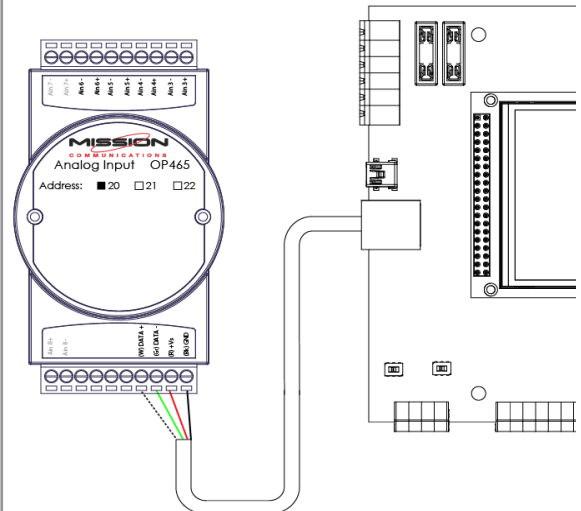

Figure 1B:
Other Expansion Modules



Warning: Wiring the expansion modules with the RJ45 communications cable connected to the MyDro can potentially cause damage to the circuit board.

Wiring Best Practices:

- Do not run signal wires parallel to load wires. If they must cross, do so at a right angle.
- Extend the RS485 cable, rather than the cables running to the instruments, if the remote sensors are a distance away.

Chapter 5: Pre-Installation



Note: Electronic keys are supplied with each RTU. They can be configured at the web portal for a variety of functions (track site visits, acknowledge alarms, service mode, config. mode). For pre-installation, keys should have service and config mode privileges.

1. Make sure the RTU is running on the latest MyDro firmware (see Table 3 for the firmware requirements at time of publication). Contact Mission Technical Support to initiate an over-the-air firmware update.
2. If the RTU is active and enabled for alarm notifications use the electronic key to place the MyDro RTU into service mode so alarm notifications will be suppressed during the installation.
3. Disconnect AC power from control panel.
4. Verify that no power is present in the work area by using a volt meter.
5. Mount the module with the self-tapping screws provided.

**Table 3:
MyDro firmware expansion recommendations**

Expansion Module	MyDro Firmware
Safe Module Plus	≥ 18.0
*Pulse Input	≥ 18.0
**Analog Input	≥ 18.0
**Analog Output	≥ 18.0
Digital Input	≥ 18.0
Digital Relay Output	≥ 18.0

* Pulse Input (OP464-30) is discontinued and cannot be ordered but can still be connected. See Appendix E for installation information.

**Base Analog Input and Analog Output channels are available with firmware versions prior to 18.0 but with fewer expansion channels.

Chapter 6: Safe Module Plus (PN OP750)

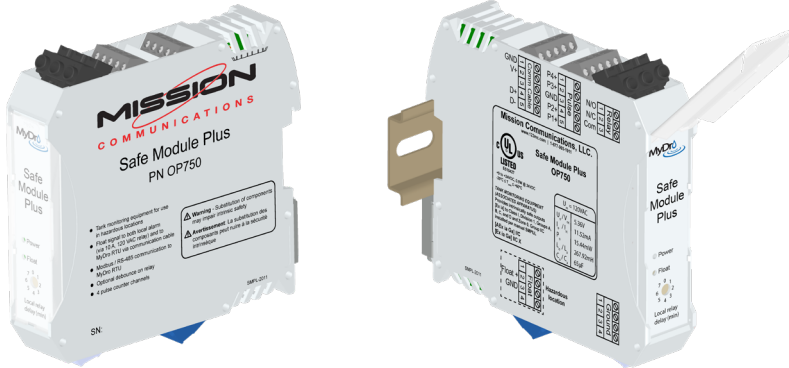

Important: Digital Input 4 can only be used for the float input of the OP750 when connected.

Safe Module Plus Overview

The Safe Module Plus (SMP) is an exclusive device that speeds and simplifies the installation of a Mission MyDro 150 or 850 RTU. It supports four pulse counting channels that can be used with rain tipping buckets or pulse-based flow meters. It provides an intrinsically safe circuit to a float so that the state of the float can be transmitted by the MyDro RTU for alarm notifications as well as to energize a built-in-relay that is typically associated with a local buzzer or light for sewer lift station applications, or service-pump lock-out for clear well applications.

NEC Rule 22-704
National Electric Code (NEC) Rule 22-704 offers comprehensive criteria for classification of hazardous locations. Sewer lift stations are generally considered Class I, Division I environments and require corresponding intrinsically safe apparatus. Methane (explosive) and hydrogen sulfide (corrosive) are common vapors present in these environments.

The float circuit associated with the SMP is certified as intrinsically safe: Class I, Div I, II, III, Groups D—G.



Note: For legacy (M110, M800) RTU upgrades that utilize the Wet Well Module, see Appendix A.



Note: The relay can drive a load up to 10 amps at 120 VAC

See the specification sheet for overview and application data and the UL Control Document for intrinsically safe application and installation information.

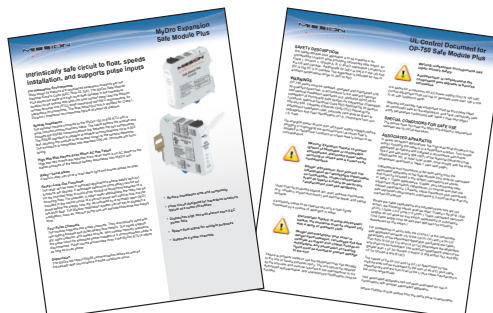

Sewer Lift Station Applications

Figure 2:
Sewer lift station application

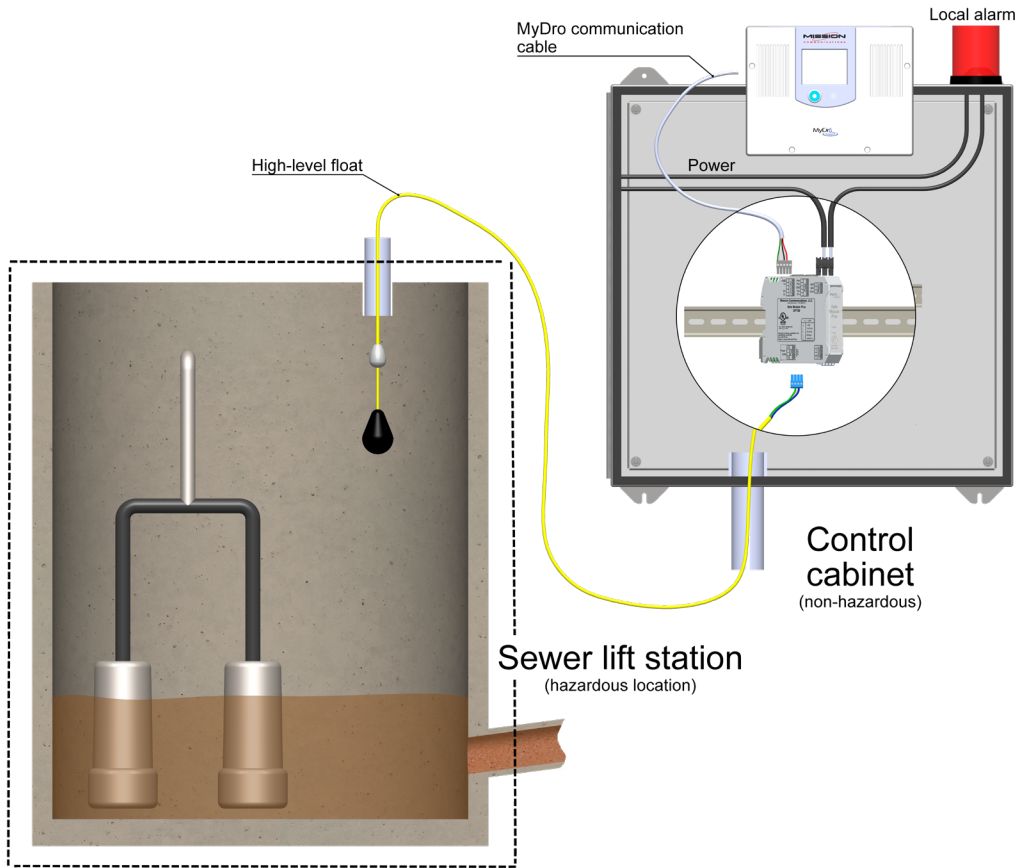

Float and Panel Wiring for Sewer Lift Station Applications

The two-wire connection to the float is not polarity sensitive. Locate (or intercept if a retrofit application) the high-level float wires and terminate them on the SMP lower float terminals. Locate or re-terminate the other two wires (that complete the circuit to the local alarm) between relay common and relay N/O.

The SMP module (located in a non-hazardous location) senses the state of float (in the hazardous area) in an intrinsically safe manner. The float tip is communicated to the Mission alarm notification system and the local relay is energized to illuminate the local alarm light.

Service Pump Lock-Out Applications

The relay can be used for other applications including fresh water applications requiring a pump lock-out. For example, a service pump drawing from a clear well, or below ground storage tank may be commanded to run by either local control or by the Mission Tank and Well Control Package (an automated remote-control system). A properly located low-level float (N/O) in the supply tank is tipped (closed) when the level is adequate (higher than the suction of the pump), therefore the pump control circuit is enabled. If or when the float drops, the relay opens, thereby locking out the local pump from operating dry.

Figure 3:
Service pump lock-out application

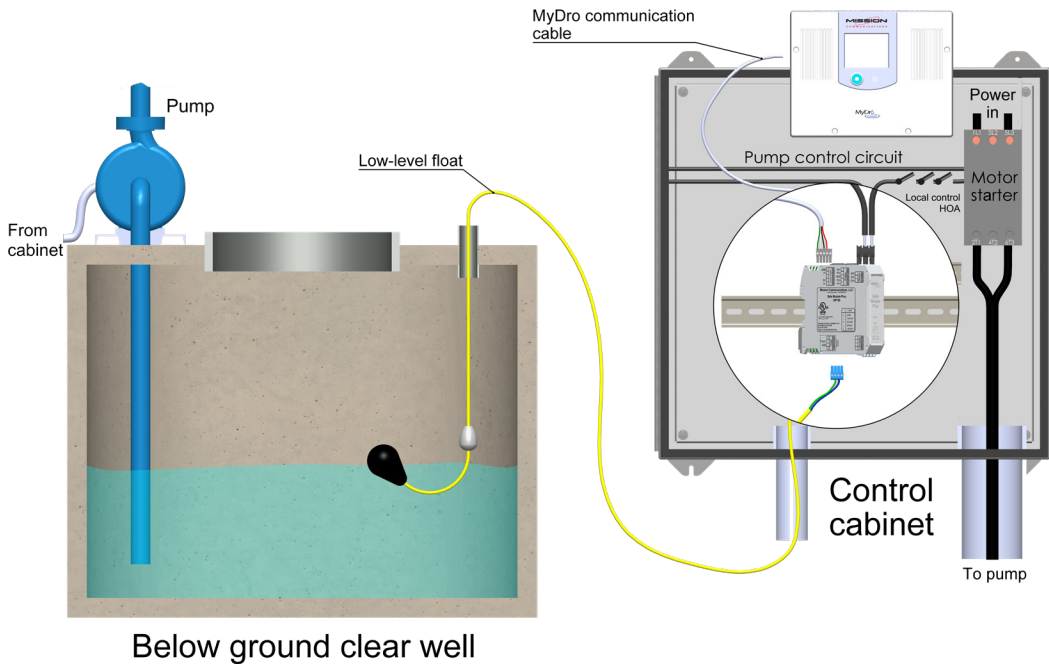

Float and Local Wiring for Service Pump Applications

The low-level float is wired to the lower SMP terminals labeled float. The SMP relay terminals labeled common are wired in series with the other components involved in controlling the coil of the motor starter (HOA switch, over temp, over pressure, other safety switches).

Debounce

Turbulent waters near the tipping point of a float can result in rapid contact closure cycles. To reduce the side effects of this situation, two types of debounce are offered. First, the local relay can be set with a debounce by way of the front facing rotary switches. Secondly, an alarm notification delay can be set from the web portal (Start Menu > Setup > RTU Setting > RTU Configuration)



Note: Generally sewer lift station applications are best served with no local relay debounce since the relay is only used to drive a local alarm light or buzzer. However, an alarm notification delay may be useful.



Note: Pump lock-out applications may benefit from a local relay debounce setting, as short cycling the pump can lead to premature pump failure.

AC Failure and Battery

Since the MyDro supplies the SMP with power and is backed up by battery, the change in float status will be reported even after AC failure.

SMP Startup and Test

Verify connections are correct, secure, and labeled. Power up the station. The RTU display should illuminate and complete the connection sequence. The RTU must be online for the next steps.



Note: An offline RTU will allow limited access to configuration menu options related to getting online. Technical Support is available to assist with connection issues.

The MyDro display is normally shown with a black background. It will turn yellow when in service or config. mode. The duration of the service mode is 60 minutes by default but can be modified from the web portal (Start Menu > Setup > RTU Setting > RTU Configuration). If pre-installation steps were followed and the installation was relatively fast, the RTU should re-synchronize in service and config. modes for the remaining time. If not, present the key and wait a few seconds for the key to be validated.

1. Confirm with Mission Tech Support that MyDro has been paged to accept SMP.
2. The green LED on front panel of SMP should illuminate.
3. Tip the float. Use the touch screen to evaluate the state of DI 4. DI 4 on the MyDro Digital screen should illuminate. The changing input state should also reflect correctly on the web portal.
4. Log into the web portal and proceed to Start Menu > Setup > RTU Setting > RTU Info to label the digital input and set the normal state properly. A high-level float is generally a N/O instrument.
5. If the output relay has been utilized then verify that the device (example: local alarm light) is working.
6. Exercise each pulse counter channel to assure proper operation. The pulse count will reflect on the third window behind the Status button on the MyDro display. The value should reflect on the web portal within two minutes for MyDro 850 and 15 minutes for MyDro 150 RTUs.
7. Perform a fail-safe test by disconnecting the communication cable from the MyDro (the RS485 terminal), waiting for the wire fault alarm to be dispatched, and reconnecting the communication cable to resume normal operations.



Note: If a relay debounce has been set via the rotary switches, wait the appropriate time.

Chapter 6.1: SMP Pulse Inputs

The SMP supports four pulse inputs. They are generally used with rain tipping buckets and pulse flow meters.

Changes to pulse readings are reported every 15 minutes for the MyDro 150 and every two minutes for the MyDro 850.

The minimum pulse width is 16 milliseconds (8 milliseconds high and 8 milliseconds low). Input impedance is 50 megohms.

Figure 4A:
Dry contact pulse input

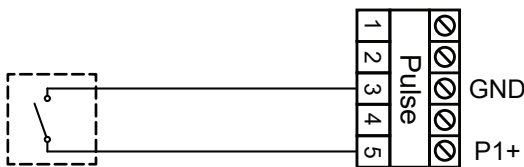

Figure 4B:
Active pulse input

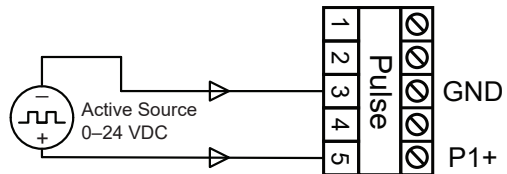

Figure 4C:
24V DC example - Active pulse input with optional voltage divider

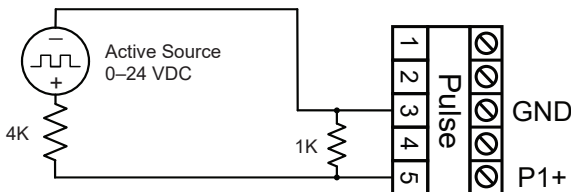
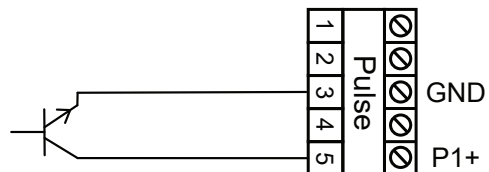
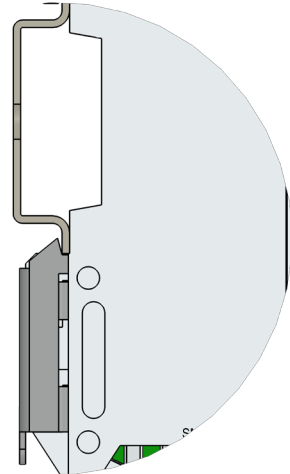
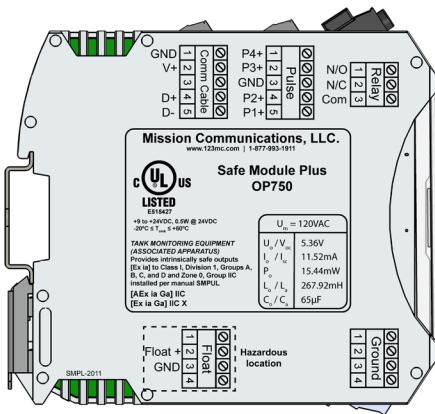

Figure 4D:
Open collector NPN transistor



Chapter 6.2: SMP DIN Rail Mount and Release

The SMP can be mounted on a DIN rail, placing the SMP onto the DIN rail and rotating down will engage the lower latch that will lock the SMP onto the DIN Rail.



To remove the SMP from the DIN rail, insert a flathead screwdriver into the open slot on the metal latch on the bottom back side of the enclosure, pull the latch down using the leverage of the screwdriver and rotate the enclosure upward and pull off the rail.

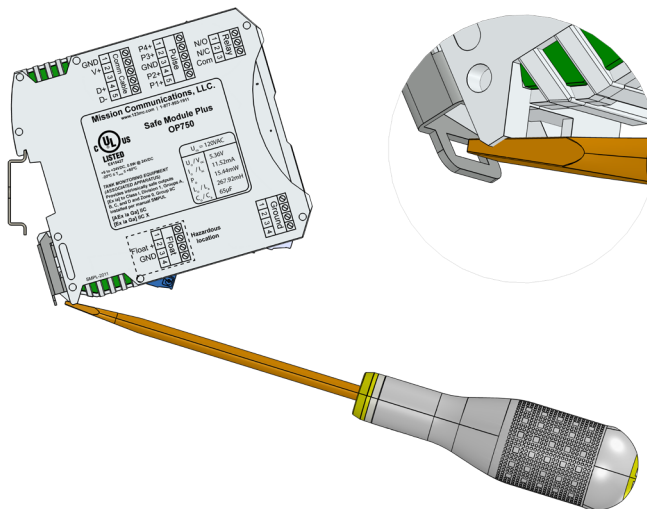

Chapter 7: Analog Input Expansion Module (PN OP465)

The Analog Input Expansion Module adds seven analog inputs to the two that are on the mainboard. Analog values are reported every two minutes with the MyDro 850. Analog expansion is best used with the MyDro 850 and is not recommended with the MyDro 150. The module supports 4–20 mA current inputs or 0–5 volt inputs.

Selection between the 4–20 mA current inputs or the 0–5 volt inputs can be set by switching the two switches described in Table 4 and shown in Figure 5. These switches are accessible from two cut-outs found on the back of the expansion module case. If the expansion module does not have these switches, then set the jumpers found inside the module as described in Table 5.

To reveal the back of the expansion module case and gain access to the switches, loosen the captive screws and remove the DIN rail clip or flat back mount. See Table 4 for switch settings.

Table 4:
Switch settings for 4–20 mA or 0–5 V

Switch	SW1				SW2			
	CH0	CH1	CH2	CH3	CH4	CH5	CH6	CH7
Switch ON	Current input mode							
Switch OFF (default)	Voltage input mode							

Figure 5:

Cut-outs providing access to SW-1 and SW-2 and an illustration map on the back of the Analog Input Expansion Module

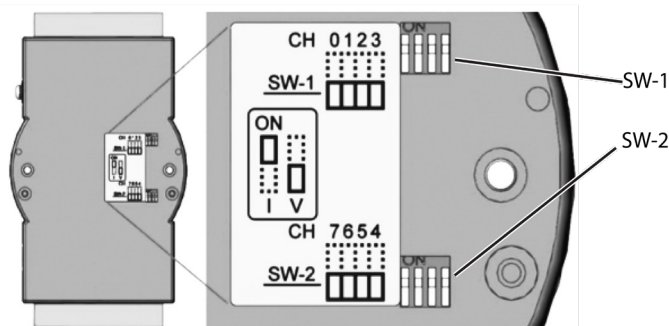

After setting the switches, match your hardware setting on the MyDro configuration screen software. To wire your current or voltage device to the expansion module, refer to Figure 6.

Figure 6:

4–20 mA current loop on Channel 3, where + is the signal from the transducer

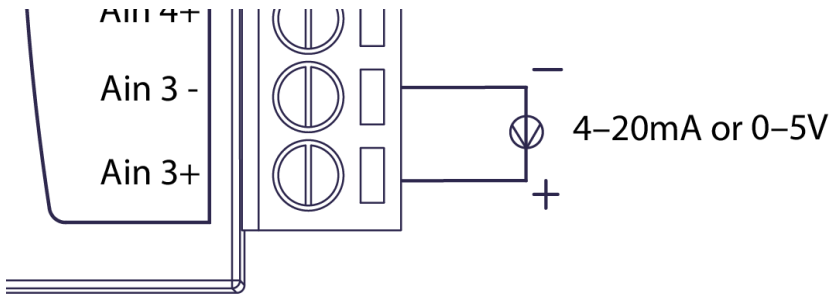

Chapter 8: Analog Output Expansion Module (PN OP461)

The Analog Output Expansion Module adds four current loop, 4–20 mA output channels (see Figure 7).

The output impedance of the Analog Output Expansion Module is 0.5 ohms. The maximum current load resistance is 500 ohms.

Figure 7:
Analog output current loop on output channel 2

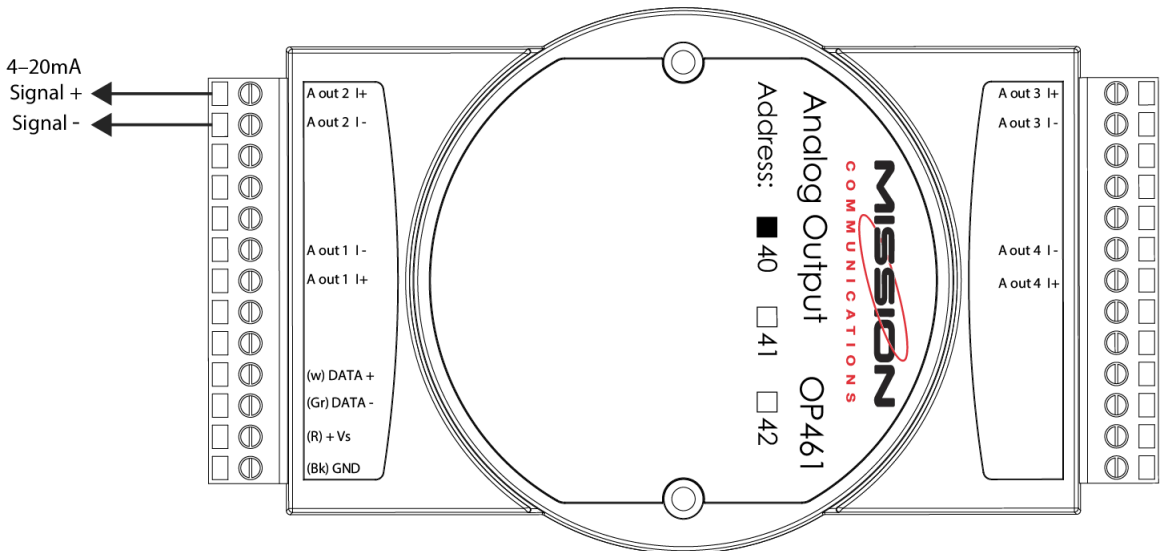

Chapter 9: Digital Input Expansion Module (PN OP653)

Eight digital inputs can be added to the MyDro (for a total of 16) with the Digital Input Expansion Module (see Figure 8). These inputs are logically treated as alarm inputs, meaning that changes in state are reported in real-time. They cannot be configured as pump start/runtime accumulators.

End-of-line resistors (wire supervision) are not supported by the Digital Input Expansion Module.

The status of expanded inputs (9–16) can be read from LEDs on the expansion module as well as the MyDro LCD screen.

Figure 8:
Dry Contact Wiring Diagram
Logic level 1: close to GND, Logic level 0: open

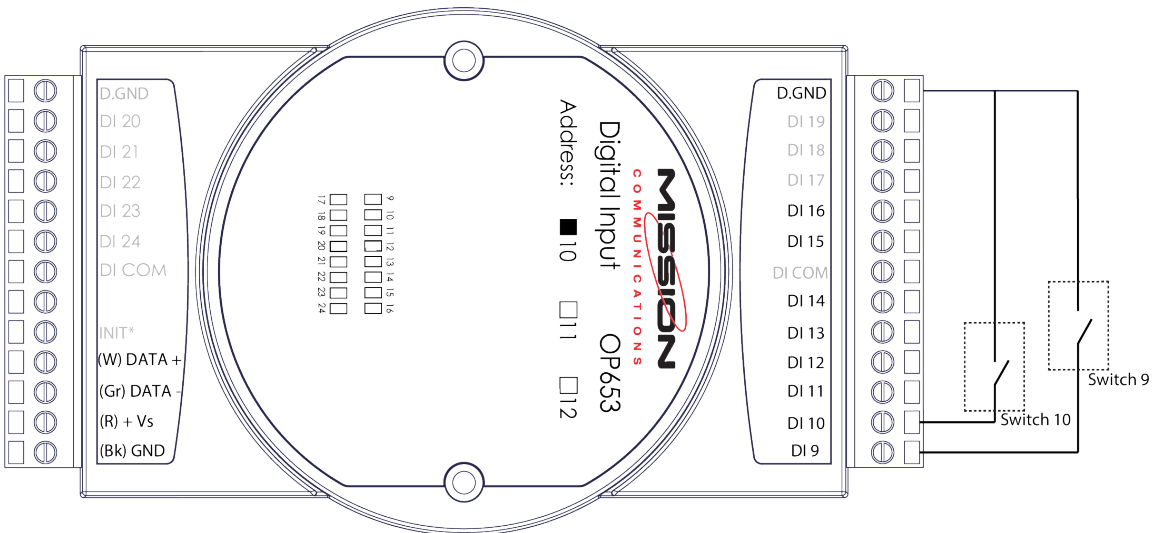

Chapter 10: Digital Relay Output Expansion Module (PN OP654)

The Digital Relay Output expansion module adds up to six digital or relay outputs to the MyDro for a total of nine (see Figure 9).

Figure 9:
Digital Relay Output expansion module

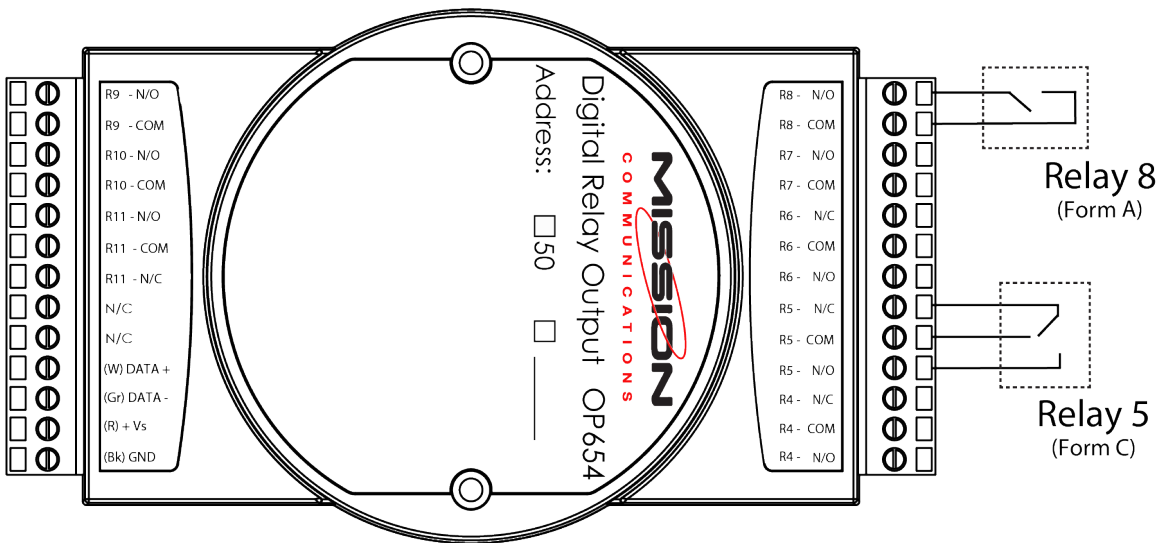

Appendix A: Upgrades from Legacy RTUs, Wet Well Modules, and Pulse Counter Expansion Boards

Legacy series (M110, M800) RTUs supported a Wet Well Module (WWM) by way of an RJ45 interface on the left side of the printed circuit board. There were two versions of the WWM (generation 1—green and generation 2—red). The MyDro does not directly support either version of the WWM. Likewise, the SMP cannot be used with any legacy RTU.

The legacy pulse board is not compatible with the MyDro units. To have pulse inputs on the MyDro units you need the SMP which provides four inputs. Follow instructions in Chapter 6.1 of this manual for wiring the four pulse channels supplied by the SMP. (Alternatively, you can connect the discontinued Pulse Input Expansion Module, which has two inputs. See Appendix E: Pulse Input Expansion Module, OP464).

The generation 2 WWM utilizes fast-install, strap-on current sensing switches to determine pump runs. The digital inputs of the MyDro RTU support these current sensing switches directly.

Wire existing current switches to DI 1, 2, etc. Use the MyDro config. menu to set these inputs appropriately.

Pump run signals from generation 1 WWM should be replaced by current switches (PN OP400.)

Refer to the MyDro Installation Manual or The MyDro 150/850 Upgrade Manual for further information.



Appendix B: Troubleshooting

Table 5:
Troubleshooting the MyDro

Problem	Probable Cause	Solution
Power LED not illuminated on expansion module	Communication cable disconnected, mis-wired, or not seated properly. Defective module	Use VOM to check voltage between red and black wires at the end of the communication cable. (must be greater than 9 VDC). Replace defective part, reseat cable.
Module performance erratic	Excessive voltage drop because of long cable. Voltage between Red and Green terminals should be greater than 9 VDC (12 VDC nominal)	Increase wire gauge, or power SMP from independent 12 VDC power supply.
MyDro display reflect changes to I/O of respective expansion modules	Verify communication cable D+ and D- are correctly wired	Correct wiring
Communication between SMP and MyDro is erratic	Long communication cable run resulting in RS485 signal issues	Use high-quality shielded wire, add terminating resistor at last device

Appendix C: Three or More Expansion Module Hookups

The RS485 standard allows multiple expansion modules on the same communications bus (see Figure 10).

Generally, several expansion modules can be powered on the aux power bus available on the MyDro. Table 1 shows the power required for each expansion module in watts. When powered by a healthy battery or AC transformer, the MyDro RTU supplies ~12–16.5 VDC, and is protected by a 0.5 amp thermal (PTC) fuse. For proper battery charging, only a total power of 3W is available from the RS485 communication jack. When more than 3W is needed, an external 10 to 30VDC power supply (PW427) is required (Figure 10).

Transducers should be powered via the aux out terminal rather than the communications cable since the auxiliary power is software selectable as 24 or 12 VDC. Higher voltage is generally recommended for analog (4–20 mA) instruments to reduce the chance of voltage starvation in long current loops or those with multiple taps (instruments).

Figure 10:
Multiple module network powered by communications cable

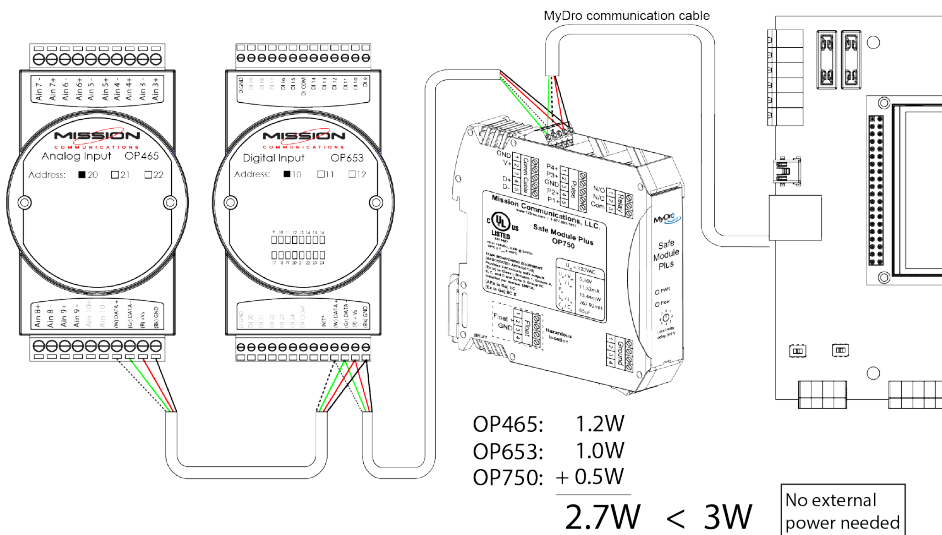

All modules can be placed in any position. V+, V- and D+, D- are wired in parallel.

The expansion modules require 10–30 VDC when more than 3 watts are required (see Figure 11). Table 1 shows the power required for each expansion module in watts.

Figure 11:
Multiple module network powered by external supply.
Cap the power ends (red, black) of the communications cable to avoid a short.

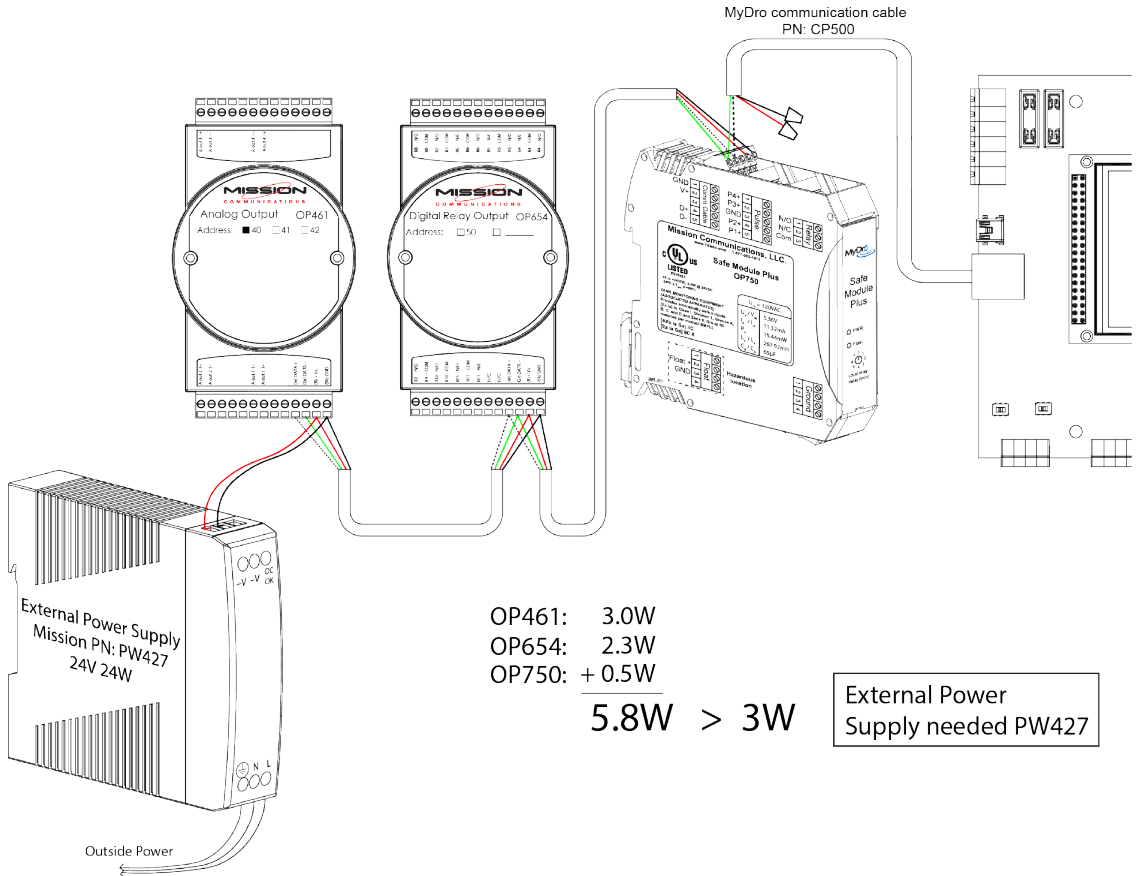

Note: All modules can be placed in any position. V+, V- and D+, D- are wired in parallel.

Appendix D: Long Cable Runs, Terminating Resistor

Generally, terminating resistors on the communications bus are not required because instruments and the expansion modules are relatively close to the RTU. Long cable runs of 50 feet or more to an expansion module may require additional consideration.

The RS485 specification recommends, but does not specifically dictate, that the characteristic impedance of the twisted data cable be 120 ohms (see Figure 12). The value of the terminating resistor is ideally the same value as the characteristic impedance of the cable (~120 ohms).

Figure 12:
RS485 impedance characteristic internal to the MyDro

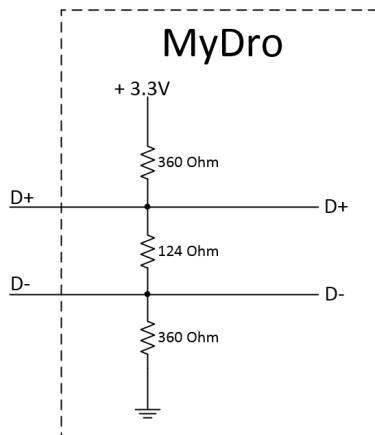

The voltage drop caused by a long cable run can be addressed with heavier conductors or a power supply that is closer to the expansion module.

Precautions should be taken to reduce interference (induced voltages) that increase with length. It is recommended to use a shielded, twisted pair wire installed in a conduit with no other noisy conductors.

Appendix E: Pulse Input Expansion Module (PN OP464, Discontinued)

The functions of the standalone (ADAM/Advantech) pulse input expansion modules can be performed by the Safe Module Plus (Chapter 6) so this option will continue to be supported but no longer supplied.

The MyDro supports two Pulse Input Expansion Modules for a total of four channels. It is generally used with rain tipping buckets and pulse flow meters.



Note: If used, the second Pulse Input Expansion Module must be ordered as PN OP464-31 so the device address is set to 31.

Changes to pulse readings are reported every 15 minutes for the MyDro 150 and every two minutes for the MyDro 850.

The minimum pulse width is set by firmware to be 16 milliseconds (8 milliseconds high and 8 milliseconds low). Input impedance is 50 megohms. The module consumes 2 watts.

Dry Inputs

Dry inputs (no voltage), typical of a rain tipping bucket, for channel 1 connect to terminal IN 1 and terminal D.GND. Likewise, channel 2 inputs connect to terminal IN 2 and terminal D.GND (see Figure 13A).

Figure 13A:
Dry contact input (rain tipping bucket) for channel 1

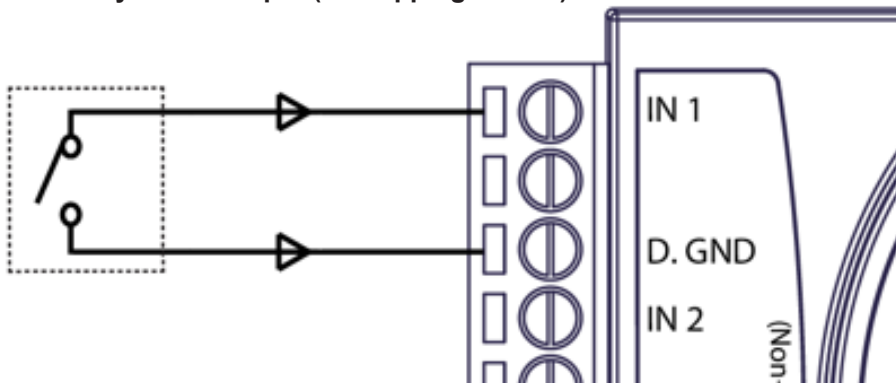

Active Pulse

Some flow meters source the voltage (active pulse). The Pulse Input Expansion Module supports up to 5 VDC wetted circuits (see Figure 14B). Polarity must be observed.

Figure 13B:

Active pulse wiring: Logic level 0: 0–0.8 V. Logic level 1: +2.4 V to 5 V
D.GND is common to (BIK) GND terminal

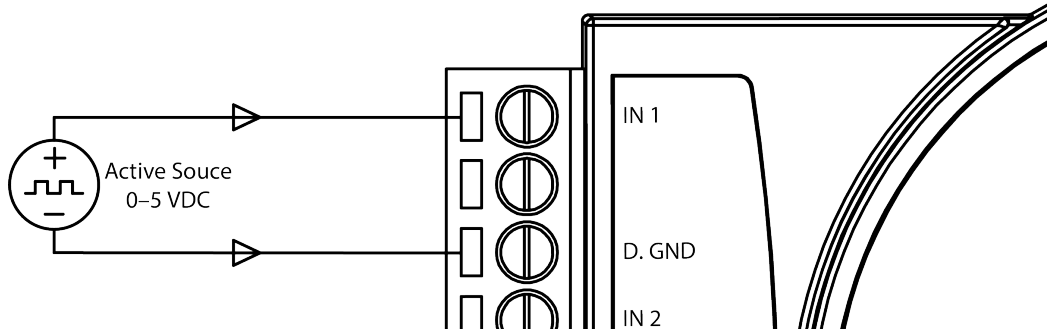

Flow meters that source voltages greater than 5 volts can be accommodated with a voltage divider circuit consisting of properly sized resistors (see Figure 14C).

Figure 13C:

Active pulse wiring with voltage divider circuit $(1K/(1K+4K)) = 20\%$.
24 V source is reduced to 4.8 V.

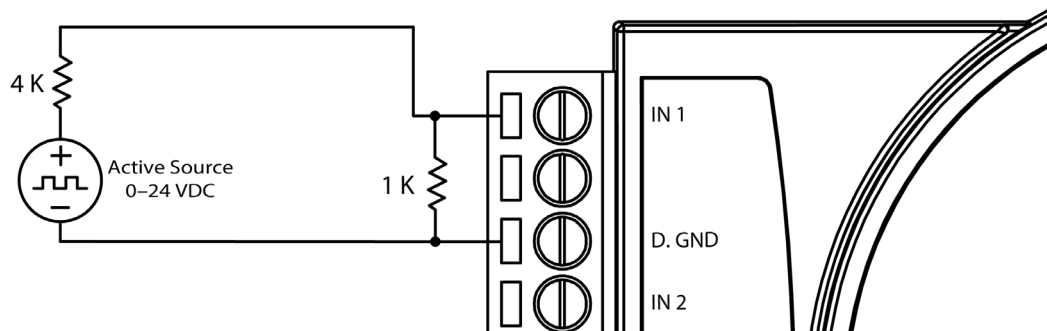

MyDro Documentation

Additional MyDro documentation can be found in the MyDro Series folder, available on the 123SCADA web portal — Start Menu > Help > Documents.

- MyDro 150/850 Installation Manual (M1M8IM)
- MyDro 150/850 Upgrade Manual (MUM)
- MyDro Data (M150/M850)
- MyDro Daughterboard Installation Guide (DIG)
- MyDro Expansion Modules Spec Sheet (MEM)
- MyDro Safe Module Plus Spec Sheet (MESMP)
- MyDro Firmware Instructions using an SD Card (MFUI)
- MyDro Flatpak Retrofit Adapter Plate Guide (MFRAPG)
- MyDro Radio Installation Guide (MRI)
- RTU Upgrade Options (RUOD)
- UL Control Document for OP-750 Safe Module Plus (SMPUL)



Web
123mc.com

Technical Support
(877) 993-1911 option 2
techsupport@123mc.com
setupforms@123mc.com

Sales
sales@123mc.com
(877) 993-1911 option 4

MEM-2405